



EasyCut

B 750, 890, 970,
B 1000 CV/CV Collect, CR/CR Collect
Mower combinations



EasyCut B en

www.krone.de

EasyCut Butterfly

Boosting your productivity



- EasyCut B 750, B 890, B 970 without conditioner
- EasyCut B 1000 CV with steel tine conditioner
- EasyCut B 1000 CR with roller conditioner
- EasyCut B 1000 CV Collect / B 1000 CR Collect with cross conveyor merger belts
- Robust, yet lightweight design
- Quick-change blades
- SafeCut INSIDE: Individually protected discs
- SmartCut for stripeless cuts
- Combi Float: Uniform pressure across the full work width (Agritechnica Silver Medal)
- Impact damage protection
- Telescoping mower arms
- Large work width, low transport height
- Maximum operator comfort





EasyCut B: The mower combination to boost your outputs. Proven best in fields around the world.

The EasyCut mower bed	4
EasyCut B 750, 890, 970	12
EasyCut B 1000 CV, B 1000 CR	18
EasyCut 1000 CV Collect, 1000 CR Collect	28
Operator interfaces	30
Select the right front mower for your KRONE triple combination	32
Technical data	34

The mower beds

A dependable design

- Fully welded cutterbar – strong in build, leak proof and permanently lubricated
- Long-lasting satellite gears with massive spur gears make for quiet running and maximum efficiency
- No inner shoe – no blockages



The original

The established system of satellite gears is a KRONE development. Ever since it was introduced in 1989, this design has proven extremely well all over the world. A driveline of massive spur gears with up to 66 teeth transfers the power all the way down to the very last disc.

Revolving at lower speeds, the large-diameter gears always have a number of teeth in mesh at any one time, giving quiet running, ultimate efficiency and maximum longevity. With each of the auxiliary gears driving just one disc, it is exposed to only minimum mechanical strain.

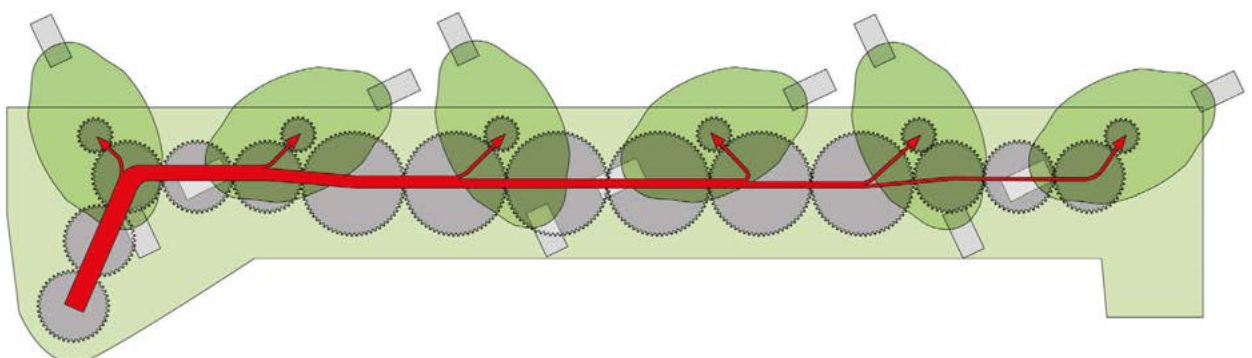

EasyCut – uniquely KRONE

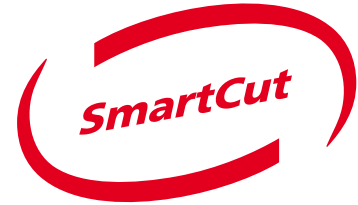

The KRONE EasyCut disc mowers provide cleanest and most accurate cuts. The enclosed and fully welded bed remains undeformed and reliably leak proof through many years of hard work. Inside, massive and oil-immersed spur gears guarantee quiet and dependable running in permanent operation and at highest workloads whilst quick-changing knives and our SafeCut disc protection system are standard fit for unmatched operator convenience.

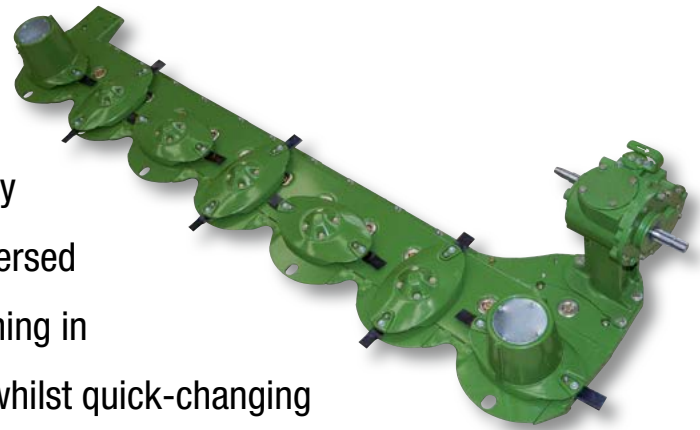

Interlocking effectively

Large-diameter gears with truncated teeth offer the benefit of interlocking a larger number of teeth at any one time, thereby transferring the power more efficiently.

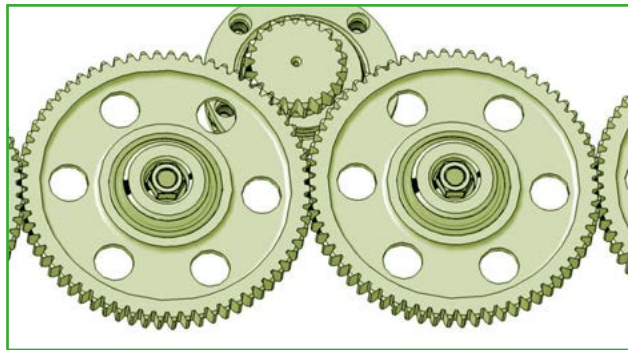

Leak proof and robust

To meet the highest quality standards we use advanced robot welding and CNC technology in the manufacture of our fully welded and permanently lubricated mower beds. After all, the cutterbar is at the heart of every disc mower.



No inner shoe

The cutterbar is powered by a right-angle gearbox, which sits right behind the inner top hat, an arrangement that ensures blockage-free operation on the headland and in awkwardly shaped fields.

The mower beds

In best shape

- Wedge-shaped mower bed for cleanest cuts
- Heavy-duty spur gears run in double bearings which are spaced at wide gaps
- Spreading and swathing from the same machine
- Hard-faced skids



Forget about stripes

With some discs turning in pairs towards each other and others away from each other, it was necessary to redesign the degree of blade overlap to get cleanest cuts. Therefore we increased the overlap between those discs that turn

outwards – a modification that leads to stripeless cuts in light and young material. Vice versa, a larger gap between the blades that turn towards each other encourages the smooth flow of large masses to the rear.

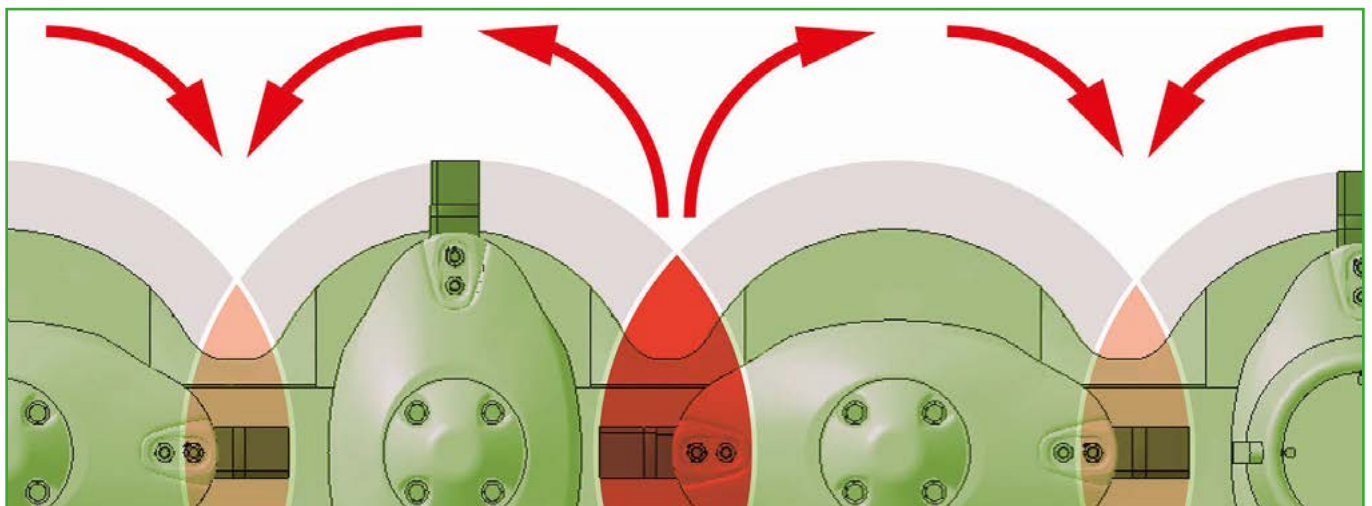

EasyCut – the better cut

The wedge-shaped cutterbar adjusts through a large setting range to cut short stubble in meadows and pastures and longer stubble in long-stemmed field crops. EasyCut cuts

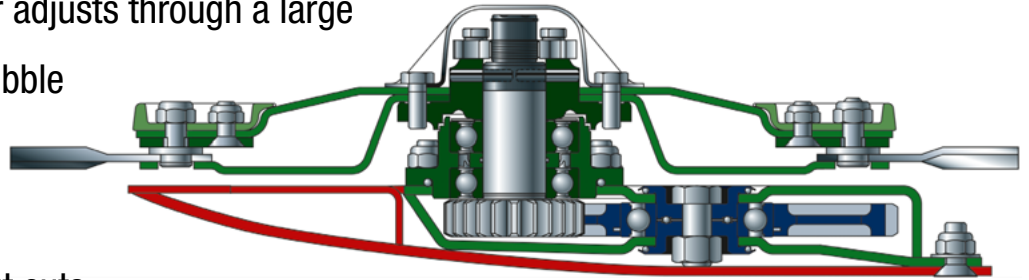

blockage-free and clean. Benefitting from massive double spur gear bearings that are spaced at large gaps, the cutterbars are heavy-duty and hardwearing.



Convenient

Some of the gears beneath the discs are arranged eccentrically in the casing. The smaller-diameter auxiliary spur gears are removed from the top whereas the large-diameter gears in the main driveline are removed from the side.

Spreading across the full width

The EasyCut models with discs spinning in the 'B' sense of rotation spread the material across the machine width. All discs spin in pairs. The benefit of spreading the crop across the full machine width is a faster and more evenly wilting.

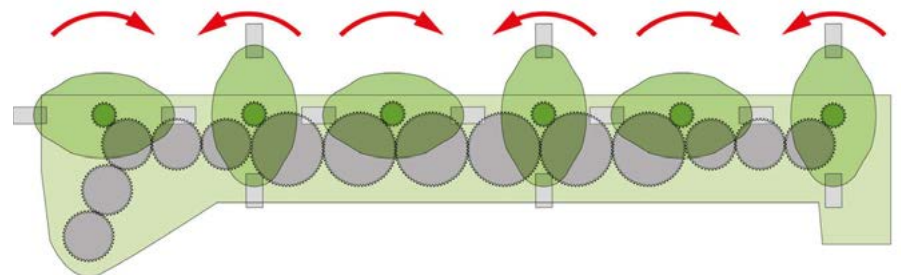

Windrowing

The EasyCut models with discs spinning in the 'A' sense of rotation windrow the material to the middle of the machine, with 'A' sense EasyCut B 970 models forming two windrows per machine.

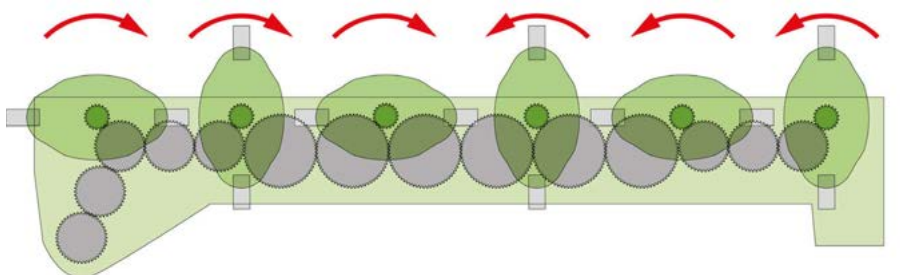

EasyCut

Perfect in every detail

- Quick-changing knives
- Replaceable knife pins and wear parts
- Minimum blade wear
360° knife action
- Excellent cuts
Optimum blade overlap



Floating skids

Made from hardened steel, the extra wide skids reduce the ground pressure for effective protection of both the cutterbar and the sward. By the way, the skids are bolted to the mower bed and are therefore very easy to replace.

Longer stubble

High-cutting skids are the solution for those who look for 80 mm (3") and longer stubble. Depending on how you bolt the skids to the bed, you increase the cutting height by 30-80 mm (1"-3").

Thorough protection

We welded rounded stops between the individual skids to protect the cutterbar from damage and contoured the underside of these stops in such a way that the material cannot collect here. As a result, the material flows smoothly to the rear.



Delivering to farmer needs

The success of all KRONE disc mowers is based on perfect performance, unmatched longevity and plenty of reasonable selling points. EasyCut mowers deliver to customer needs. Quick-change blades, hardwearing parts and a perfect disc alignment for stripeless cuts are only some of the benefits EasyCut users buy.



Changing knives within no time

Change blades in the field fast and without effort. Quick-change blades are simply a must for many users.

Minimum wear

With the knives being free to spin through 360° on their pins, they will not foul with the knives on the neighbouring discs and suffer from less wear and are self-cleaning.



Cost saver

Worn knife pins and wear parts are not an issue for KRONE EasyCut, where each part can be replaced individually. Upon special request, the knife pins may be substituted with threaded bolts.

Cleanest cuts guaranteed

112mm (4.5") knives with set blades orbit with a generous overlap, producing the typically clean cut and feeding the material to the rear in a consistent and smooth flow.



SafeCut

Individual protection for each disc

- Full driveline protection
- Neighbouring discs will not collide
- No wear and damage
- Quick roll pin change, minimum costs



Full protection

Orbiting within the sphere of the mower bed and never protruding beyond the skids, the EasyCut discs enjoy two-fold protection in addition to the standard-fit SafeCut shear-off system.

An ideal system

As the discs are spinning, they place no load on the roll pins, because the bearings are tensioned by a nut and two clamping screws. As a result, the roll pins do not suffer from material fatigue and even after many hours of operation they will break only at their inbuilt load level.

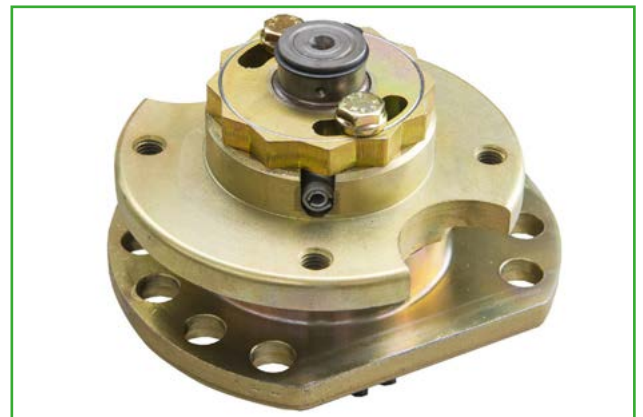

EasyCut – uniquely KRONE

The situation is familiar to every farmer – a disc hits a foreign object, gets damaged and needs replacing. In this situation, KRONE SafeCut offers a maximum of protection. The DLG Gold winning new disc shear-off system brings a new level of protection and operational reliability to the EasyCut mowers with and without CV conditioner. SafeCut is standard equipment on all EasyCut disc mowers.



**SafeCut
INSIDE**

Peace of mind

Instead of transferring the full shockload to the spur gears, the roll pin in the sprocket driveshaft breaks when there is a momentary overload. The pinion shaft continues spinning, jacking up the disc in question and the disc moves out

of the risk zone and the orbit of the neighbouring discs. This way SafeCut prevents damage to the spur gears and the neighbouring discs. Replacing the roll pin takes a few minutes and is not very costly.





EasyCut B 750, B 890, B 970

Perfect in every detail

- Huge work widths of up to 9.70 m (31'10")
- Optimal overlap – EasyCut B 890 and B 970 with telescoping arms
- Compact break-back headstock for smoothest ride
- Balancing arm distributes the ground pressure uniformly to both ends



Standard impact damage protection

Safety is another important aspect of our mower combinations. For example, to avoid obstacles EasyCut B 750 swings back through 1.20 m (3'11"), EasyCut B 890 through 1.40 m (4'7") and B 970 through 1.60 m (5'3"). Once the system is triggered, the complete mower swings back and up and away from the obstacle. Once the obstacle is passed, the unit automatically resumes its working position.



Optimum protection

These mowers use a coil spring to set the tripping force of the impact protection system, which trips instantly when the unit meets an obstacle.

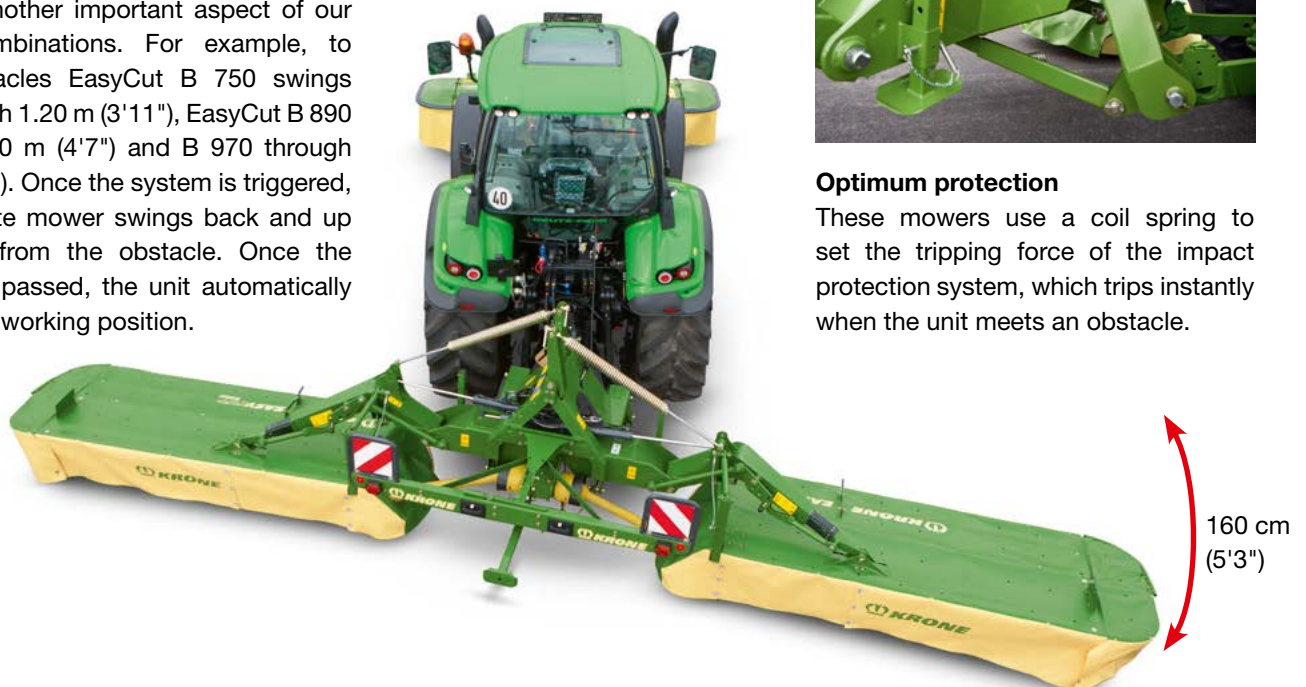

Mowers of finest engineering

Committed to greatest efficiency in any respect, KRONE manufactures mower combinations that stand out for their high performance and ease of pull – an achievement of a robust and advanced technology that delivers superior functionality and perfect 7.46 m (24'6") to 9.70 m (31'10") cuts.



The central gearbox

Mounted centrally on the rear unit, the main gearbox sends the tractor power down the straight drivelines, which feature integral overload protection, clutches and overrunning clutches to protect the mower and tractor. Required pto speed is 1,000 rpm.

DuoGrip center-of-gravity suspension

The robust headstock offers a compact and uncluttered design. The decks do not suspend centrally but in their center of gravity and receive extra guidance from lateral arms. The DuoGrip center-of-gravity suspension system maintains a uniform ground pressure across the entire work width, easy pulling, great ground contour hugging as well as a large pivot range.



Maintaining the ground pressure

The suspension arms ensure both wings operate at identical pressures in undulating terrain, which is evidenced by the uniform cut. The spring pressure is set on a turnbuckle.

Adjust the overlap...

... and forget about stripes

- Overlap control without the use of tools on EasyCut B 890 and B 970
- Generous overlaps in bends and on slopes
- No fiddling with transport height

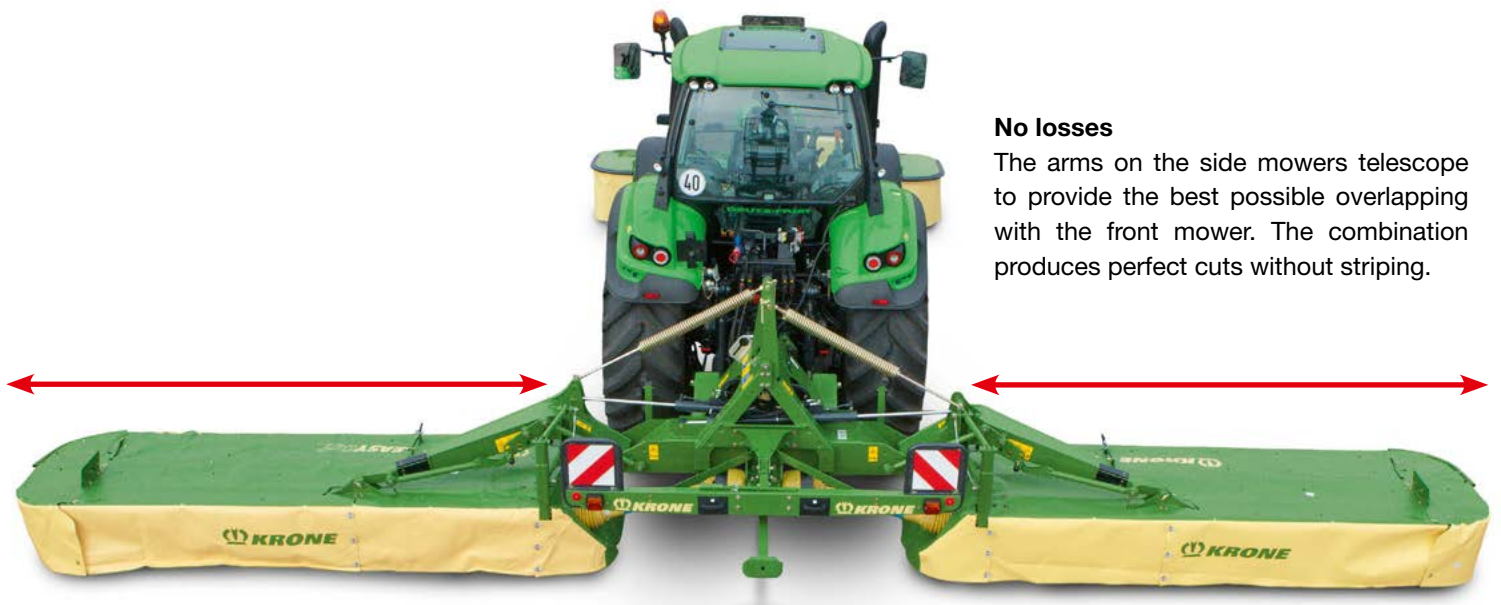

No losses

The arms on the side mowers telescope to provide the best possible overlapping with the front mower. The combination produces perfect cuts without striping.

A perfect system

EasyCut B 890 and EasyCut B 970 operators can alter the space between the two side mowers to eliminate striping on slopes and in bends. The standard telescoping arms adjust each wing to overlap up to 45 cm (1'6") with the 3.16 m (10'4.5") front mower. Set up this way, the combination produces cleanest, loss-free cuts in the most difficult terrain. Vice versa, you can set the combination to its maximum span to sweep large fields in flat terrain at staggering rates.



As easy as it gets

Set the overlap on a pin on each mower arm. The setting does not affect the unit's transport height.

Telescoping

Combined, the wings and the 3.16 m (10'4.5") EasyCut B 890/EasyCut B 970 front mower offer three different settings to provide the required overlap:

Position I : 30.00 cm (1') overlap

Position II : 38.00 cm (1'3") overlap

Position III : 45.00 cm (1'6") overlap





Easy handling

It's practical and convenient

- Operator box for maximum comfort
- Operate the side mowers in synch or individually
- Compact transport dimensions: 4.00 m (13'2") max. transport height, 25 cm (10") ground clearance, 2.95 m (9'8") transport height



Everything is possible

Raise both mowers simultaneously as you approach the headland or individually to finish up wedges or awkward areas.



Boosting efficiency

KRONE mower combinations offer professional farmers and contractors the specification and operator comfort they deserve: A large work width, an enormous efficiency and compact build, as well as a low tractor input, ease of operation and excellent handling are parameters that set new standards in this category.



Nice and compact

Offering 3.70 m (12'2") to 4.00 m (13'2") storage heights and a 2.95 m (9'8") width, EasyCut B 750, B 890 and B 970 require little storage space and are parked on sturdy stands. And despite the generous 25 cm ground clearance the machines transport height does not exceed 4 m (13'2").

Secure locking

These latches secure the EasyCut B 750 wings in transport position. This system gives peace of mind when travelling at speed between fields.



Convenient

EasyCut B 890 and EasyCut B 970 are secured in their transport position by hydraulic check valves, which lock and release the units automatically as these move into work/transport position.



Raised by double-acting rams

The short single-acting rams raise the mowers into headland position whereas the long double-acting rams ensure lift/lower is safe on slopes as well.



EasyCut B 1000 CV, B 1000 CR

Redefining acreage

- Up to 10.10 m (33'2") work width
- EasyCut B 1000 CV with steel tine conditioner
- EasyCut B 1000 CR with grippy roller conditioner
- Hydraulic balance control maintaining the ground pressure
- Impact damage protection



Carefully designed

The standard impact damage protection system on EasyCut B 1000 CV and B 1000 CR gives you peace of mind as you cut along borders, fences and hedges and when the machine hits an obstacle. When a wing deck hits an obstacle it swings approx. 1.50 m (4'11") to the rear. Once the obstacle is passed, the unit returns automatically into its working position.

Adjustable

The KRONE impact protection system responds instantly and dependably. It's tripping force is set steplessly on the coil springs.

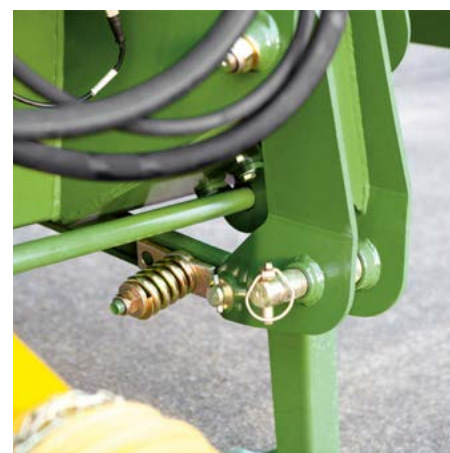
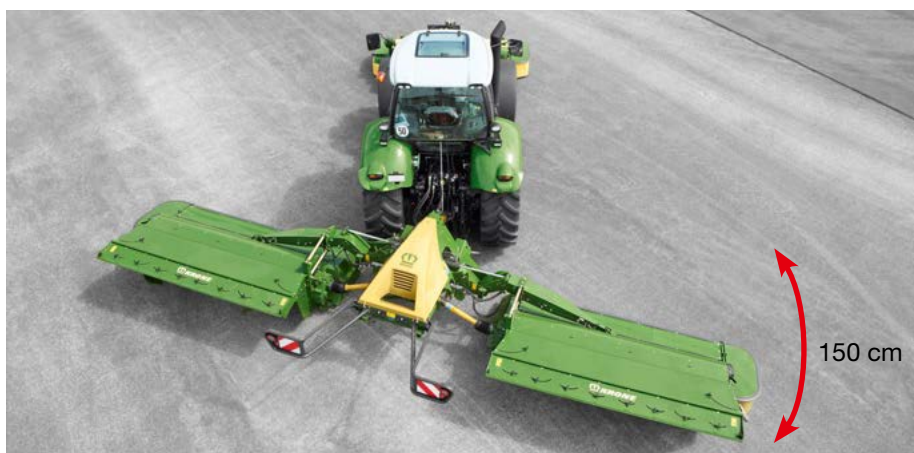

Combi Float – the intelligent solution

Combi Float is a special feature on EasyCut B 1000 CV and EasyCut B 1000 CR with their huge 10.10 m (33'2") work widths and high performance CV or CR conditioner. The automatic and hydro-pneumatic Combi Float control system is a unique system that is not available elsewhere. It integrates the tractor's hydraulic system, thus making up for the shortcomings of hydro-pneumatic pressure control systems.

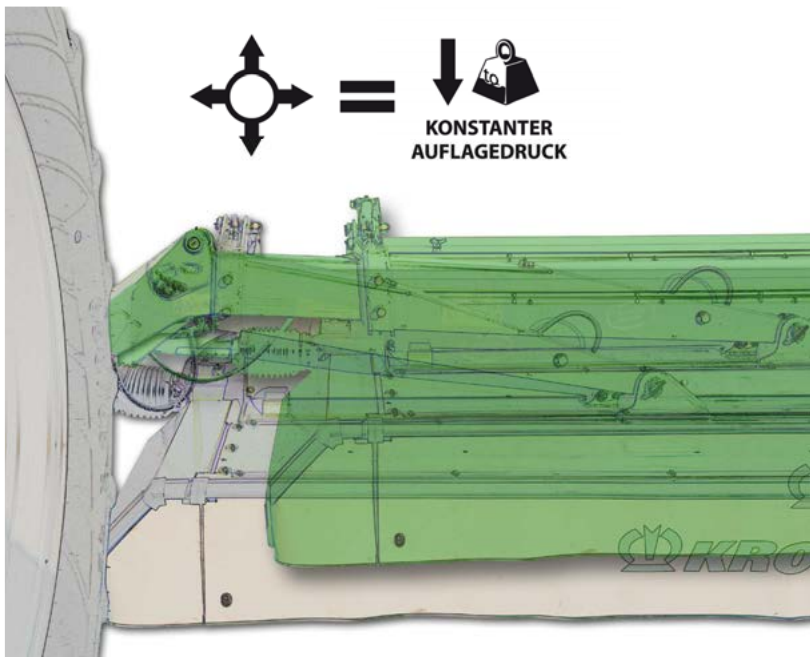

Combi Float is a unique system that offers plenty of benefits

- The automatic suspension control system maintains identical pressures on both wing mowers when they work in offset position and in undulating fields
- Easy adjustment of the mower suspension system from the tractor seat and on the move
- Lightweight, hardwearing, easy pulling and compact

An integral system :

The compact headstock features integral rams, valve chest and accumulators to reduce its weight and hence the load on the tractor's hydraulics. It also features an easy-to-open cover for effective protection.

Combi Float – only from KRONE

The speciality of the system is the fact that it uses extra spools and the circuit of the single-acting coupler with free return line to maintain the pressure inside the reservoirs of the hydro-pneumatic system. The advantage of this system is that it maintains a uniform suspension of both mowers in undulating terrain and when working at various work widths.



Forget about stripes

Nothing is left behind

- Hydraulic overlap adjustment
- Large setting range of up to 40 cm (1'4") per side
- Clean cuts in bends and on slopes



Adjusting to the optimum

The mower arms on the EasyCut B 1000 CV and 1000 CR side mowers extend and retract like telescopes. As you move both mowers out or in, you alter their overlap relative to the front mower and thus the total work

width. When using an EasyCut front mower of a 3.16m (10'4") work width, you can set overlaps from 110 to 530 mm (4" to 1'9") on each wing. To avoid striping on slopes, shift the wings to the same side.



Variable overlaps for full flexibility

A wide variety of conditions asks for the proper equipment to match.

The hydraulic sideshift feature on the mower wings is standard specification, which eliminates striping and maximizes your efficiency. Cutting straight lines, you operate at the maximum width and set overlapping to the absolute minimum, whereas you want wider overlaps and a narrow work width when you are cutting around bends. As you operate on the slope, simply retrieve a stored sideshift range to the right or left and avoid drifting and striping.

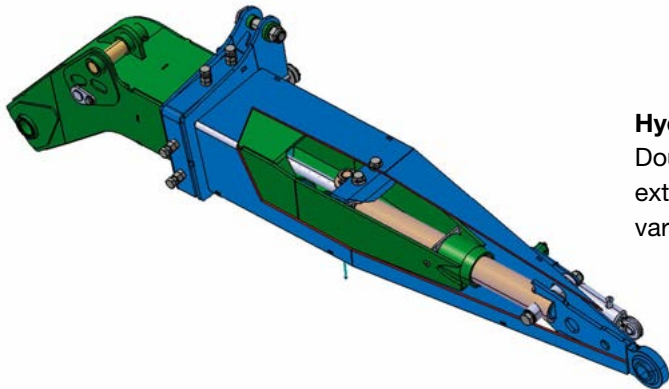

Hydraulic control

Double-acting rams inside the mower arms extend and retract the arms on the move to vary the degree of overlap.

Flexible

The wing decks shift up to 40 cm (1'4") to either side. Such a large range of shifting makes for cleanest cuts in difficult conditions.

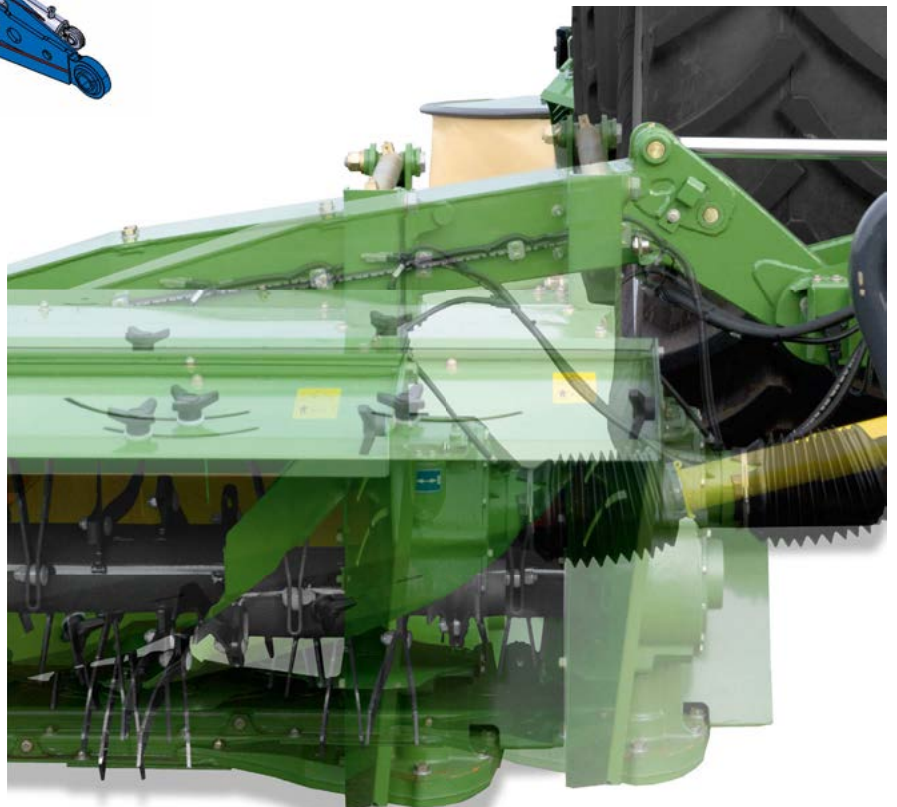

Built-in road stability

Excellent handling in all situations

- Excellent visibility from less than 3.0 m (9'10") transport width
- Safe road transport: 4.0 m (13'2") transport height at 20 cm (7.9") ground clearance
- Outstanding operator comfort
Compact on the tractor, adjustable tractor-machine clearance
- Winter storage in transport position



Everything is possible

All three mowers lift and lower at the touch of a button when the tractor approaches the headland. You can operate the front linkage from the valve chest on the rear combination. Cutting wedges or awkward plots is easy as you use one or two mowers. The machine is

not running on cut material. EasyCut B 1000 CV not only delivers an exceptional performance in large fields but also in smaller plots, producing clean cuts and well conditioned forage.



Gigantic in the field Compact on the road

As they fold into transport position the side mowers automatically retract to not exceed a 4 m (13'2") transport height. An automatic transport locking system provides for safe road travel and is activated as you slide in the rear mowers.



Compact storage

Store the side mowers on their sturdy stands in upright position and save space for more equipment in your shed.

Automatic folding

For a reduced transport height the end guards on each mower fold up automatically as the machine folds up.



Innovative steering

The wings are raised by compact double rams, which make machine operation easier for the operator. The single-acting rams lift the mowers to headland position; the double-acting rams fold them into transport position.

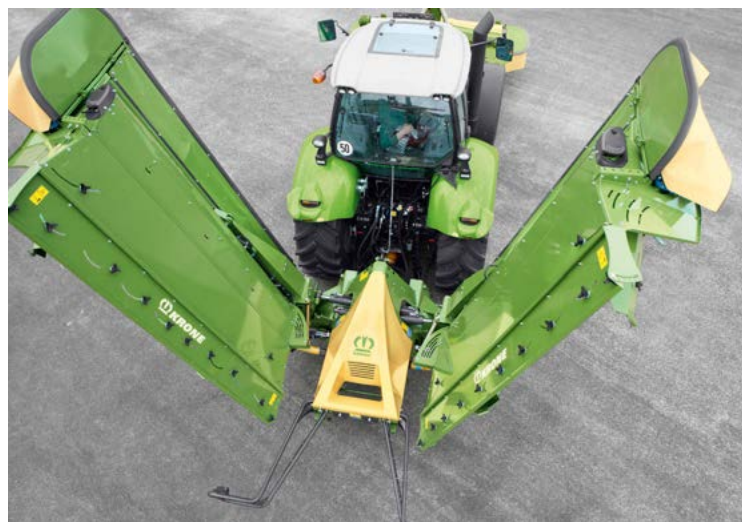

CV conditioner

V-shaped steel tines for higher intensity

- V-shaped steel tines at steep angles give strong and perfect conditioning
- The driveline without belts – frictional and low-maintenance
- Operator convenience from mechanical conditioner gearbox
- Adjustable baffle plates for enhanced conditioning



Full-width cover

The V-shaped steel tines on each mower span across the entire work width and from the left to the right drum, providing a uniform crop flow across the full width and of course optimum conditioning. Guide plates are available for wide spreading and even faster conditioning.

It's intensive

The CV conditioners that are used on the EasyCut B 1000 CV mowers have standard baffle plates. These support the tines and increase the degree of conditioning.

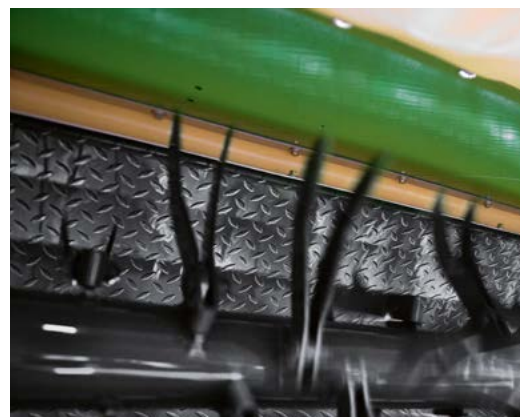

Short-cut to top quality

Efficiency is one parameter in hay and forage harvesting, quality is another. The high-performance and 640 mm (2'1") diameter KRONE CV conditioner with V-shaped steel tines spreads the crop at the full working width. Its massive rotor diameter and the helical arrangement of the tines warrant a continuous crop flow, high intakes and superior conditioning.

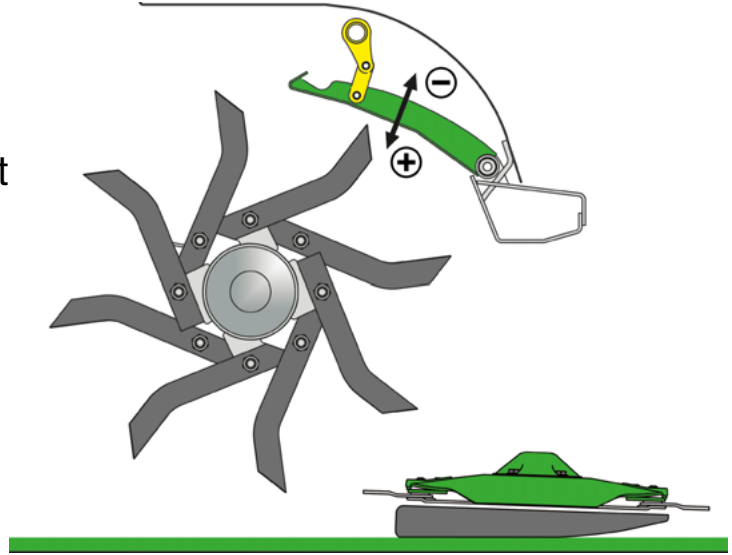

Firm grip on the crop:

The V-tines are made from hardened steel and mount at a steep angle, treating the forage intensively and powerfully. The tines pivot to avoid foreign objects, yet their forward movement is restricted to increase the service life of the bolts.

Stepless baffle plate adjustment

The tine-plate clearance is adjusted from a 7-notch system and presents another option to alter the degree of treatment. As you reduce the gap you increase the intensity of conditioning.

The mechanical gearbox

Select 900rpm for intensive treatment and 600rpm for less intensive conditioning. Setting the speed is easy from the mechanical gearbox.

Adjustable windrow width

The optional deflectors adjust to spreading. Choose between narrow windrowing in wet and boggy terrain and spreading when rapid drying is the priority.



The CR conditioner

Grippy rollers

- Continuous crop flow from 25 cm (10") diameters
- High throughputs from powered processor rollers
- Top-notch conditioning effect from meshing surfaces
- Great longevity from polyurethane coating



Full-width treatment

The full-width CR rollers ensure a uniform conditioning across the full work width whilst the polyurethane coating gives continued resistance to abrasion and wear.

Firm grip on the crop

The large-diameter chevron profiled rollers interlock to crimp, rub and crush the crop at great intensity.



The CR conditioner – the best choice for lucerne

Leafy crops like lucerne and clover require a different type of conditioning than crops that are predominantly grass.

The CR roller conditioner is just the right conditioner for these crops, leaving the delicate leaves intact that are so rich in valuable protein to safeguard the value of farm-grown feedstuff. Spreading the crops wide, the system also makes for faster wilting. This optional CR conditioner version complements the KRONE range of mowing equipment to meet all farming needs.



Spring suspension

The top roller's spring loaded suspension translates into a continuous flow even in uneven crops. Thanks to stepless adjustment of roller clearance and pressure, the system easily adjusts to the current crop yield and variety.

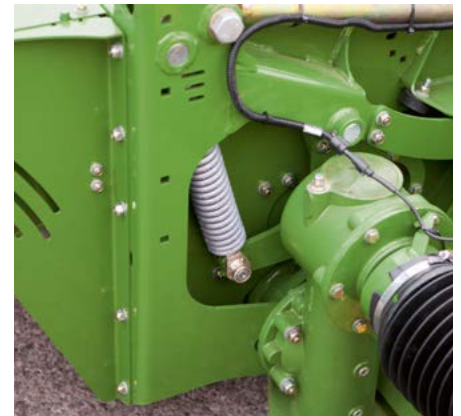

250 mm (10") in diameter

The massive CR rollers warrant a smooth and consistent crop flow whilst requiring only modest input power.



Frictional connections

The drive power to the roller conditioner flows directly and slip-free via gearboxes. The bottom roller drive is integrated in the cutterbar gearbox behind the inner top hat.



Double power

The speed of the powered top roller is synchronized with the bottom roller by an optional gearbox, which mounts on the outside of the mower bed. With this level of specification the machine is kitted out to deal with the heaviest of crops.



With cross conveyor belts

EasyCut B 1000 CV Collect
EasyCut B 1000 CR Collect

- Individual belt lift/lower offers full flexibility: either both wings are spreading the material or one wing only is spreading or each wing is producing a single windrow
- Wide cross belts ensure a continuous crop flow
- Electric height control of accelerator rollers and variable belt speeds provide for variable windrow widths
- Conditioner tray on EasyCut 1000 CV for loss free windrowing



High workrates

Nothing is left behind when the wide cross conveyors with riveted feed plates start moving.

Adjustable windrow width

The adjustable belt speed and optional electric height control accelerator rollers allow to tailor the windrow width to the following harvester.

Separate hydraulic system

The cross conveyor belts are driven by an on-board hydraulic system. An oil cooler protects the system from overheating.

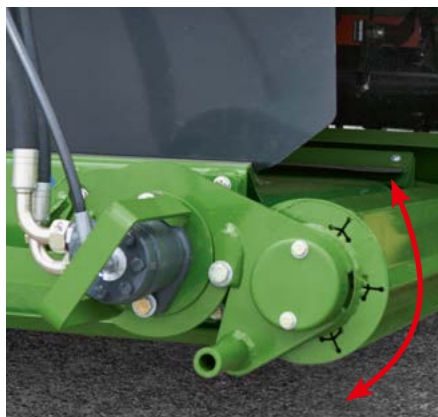

Three into one, two or three will go!

EasyCut B 1000 CV with steel tine conditioner and EasyCut B 1000 CR with roller conditioner are available with Collect conveyor belts, which provide full flexibility in presenting the windrows including spreading. The powerful belts handle even the heaviest crops most effectively.



1. Full-width conditioning

Raise the belts and spread the material across the full working width.

2. The independent windrowing

Operate only one belt to clear a pass along the border. Working up and down with only one belt in action, the three mowers form four windrows of a combined 13 m (42'8") width from a 19.40 m (63'8") work width – ideal for further wilting and windrowing in one single operation by the KRONE Swadro 2000 six-rotor center-delivery rake.

3. Cab based control

The cross conveyors lower and lift hydraulically either at the same time or independently. The conveyor is shut off automatically when the unit lifts out of work. The conditioner tray is available for the steel tine conditioner where it ensures no crop is lost.

3. Central windrowing

The Collect System groups three passes into one – cutting, conditioning and windrowing, thereby reducing the number of passes and the degree of compaction as well as the damage to the turf and contamination of the crop.



Operator interfaces

Tailored to your tractor

- Convenient
- Clutter free
- Easy use
- CCI-ISOBUS – one box for all applications and machines



Easy operation

The control unit for EasyCut B 750, B 890 and B 970 offers straightforward and easy use. The operator selects transport position, headland and work position on the rocker switches. He also controls each mower separately from here.



Delta terminal

The Delta terminal controls the mower suspension, overlap, sideshift and the cross conveyors. The job time is retrieved via the client count feature.



Practical and convenient

A machine must be easy to operate. Therefore, we offer two operator units for EasyCut B 1000 CV, B 1000 CR, B 1000 CV Collect and B 1000 CR Collect – Delta and CCI 200.

These terminals have a colour touchscreen, are clear and easy to use. The CCI terminal is a universal operator control unit that is compatible with a wide variety of ISOBUS implements from many manufacturers. A separate hydraulic line allows the operator to lift and lower the mower via the control chest on the rear unit.



CCI 200 ISOBUS operator terminal

This operator box not only comprises the same functionality as the Delta terminal but is also compatible with third-party ISOBUS equipment. Active key backlighting enhances operator convenience at night.



CCI 200 terminal with AUX port

The optional joystick (AUX) duplicates all major terminal functions and brings them to your fingertips, with buttons being fully customizable.











ISOBUS tractor terminal

The tractor's ISOBUS terminal offers the additional plus of raising all decks automatically when the tractor goes into reverse. It also incorporates an area meter that clocks the area covered.







Perfect overlaps

Select the right EasyCut front mower for your KRONE triple combination

	 F 280 M	 F 280	 F 320 M	 F 320	
B 750 	37 cm (1'2.6")	36 cm (1'2.2")	58 cm (1'10.8")	57 cm (1'10.4")	
B 890 			30 cm - 38 cm - 45 cm (1' - 1'3" - 1'5.7")	29 cm - 37 cm - 44 cm (11.4" - 1'2.6" - 1'5.3")	
B 970 			30 cm - 38 cm - 45 cm (1' - 1'3" - 1'5.7")	29 cm - 37 cm - 44 cm (11.4" - 1'2.6" - 1'5.3")	
B 1000 CV (Collect) 					
B 1000 CR (Collect) 					

Information is in cm and refers to one wing



 F 320 CV	 F 360 M	 F 360	 F 360 CV	 F 360 CR
	52 cm - 60 cm - 67 cm (1'8.5" - 1'11.6" - 2'2.4")	51 cm - 59 cm - 66 cm (1'8.1" - 1'11.2" - 2'2")		
	52 cm - 60 cm - 67 cm (1'8.5" - 1'11.6" - 2'2.4")	51 cm - 59 cm - 66 cm 1'8.1" - 1'11.2" - 2'2")		
13 cm - 53 cm (5.1" - 1'8.5") stepless			35 cm - 75 cm (1'1.8" - 2'5.5") stepless	
				35 cm - 75 cm (1'1.8" - 2'5.5") stepless



Technical Data

Mower combinations

		EasyCut B 750	EasyCut B 890
Work width	approx. mm	7.460 (24'6")	8.600-8.900 (28'3"-29'2")
Work width per rear mower	approx. mm	2.730 (9')	3.165 (10'5")
Total transport width	approx. mm	2.870 (9'5")	2.990 (9'10")
Storage height	approx. mm	3.450 (11'4")	3.700 (12'2")
Transport height at 250 / 200 mm ground clearance	approx. mm	3.350 (11')	3.600 (11'10")
No. of discs*		8	10
No. of top hats*		4	4
Quick-changing knives		Standard	Standard
SafeCut		Standard	Standard
Conditioner		-	-
Rotor diameter	approx. mm	-	-
Conditioner speed	rpm	-	-
Cross conveyor belts		-	-
Pto	rpm	1.000	1.000
Spools required		2 sa	1 sa and 1 da
Load-sensing		-	-
Dead weight*	approx. kg (lbs)	1.380 (3,042)	1.600 (3,527)
Power requirement	kW/hp	100	120
Area output min. approx.	ha/h (acre)	7-10 (17-25)	9-12 (22-30)

*without front mower

**or load-sensing



	EasyCut B 970	EasyCut B 1000 CV	EasyCut B 1000 CV Collect	EasyCut B 1000 CR	EasyCut B 1000 CR Collect
	9.400 - 9.700 (30'10" - 31'10")	9.300 - 10.100 (30'6" - 33'2")	9.300 - 10.100 (30'6" - 33'2")	9.300 - 10.100 (30'6" - 33'2")	9.300 - 10.100 (30'6" - 33'2")
	3.600 (11'10")	3.600 (11'10")	3.600 (11'10")	3.600 (11'10")	3.600 (11'10")
	2.990 (9'10")	2.950 (9'8")	2.950 (9'8")	2.950 (9'8")	2.950 (9'8")
	4.100 (13'5")	4.200 (13'9")	4.200 (13'9")	4.200 (13'9")	4.200 (13'9")
	4.000 (13'2")	4.000 (13'2")	4.000 (13'2")	4.000 (13'2")	4.000 (13'2")
	12 (8)	12	12	12	12
	4 (8)	4	4	4	4
	Standard	Standard	Standard	Standard	Standard
	Standard	Standard	Standard	Standard	Standard
	-	V-steel tines	V-steel tines	PU roller	PU roller
	-	640 (2'1")	640 (2'1")	2 x 250 (2 x 10")	2 x 250 (2 x 10")
	-	600/900	600/900	750	750
	-	-	Serie	-	Standard
	1.000	1.000	1.000	1.000	1.000
	1 sa and 1 da	1 sa and free return**	1 sa and free return**	1 sa and free return**	1 sa and free return**
	-	Standard	Standard	Standard	Standard
	1.980 (4,365)	3.400 (7,596)	3.880 (8,554)	3.400 (7,496)	3.880 (8,554)
	95/130	130/180	145/200	180	200
	10 - 14 (25 - 35)	10 - 14 (25 - 35)	10 - 14 (25 - 35)	10 - 14 (25 - 35)	10 - 14 (25 - 35)

Specifications, weights and dimensions herein do not necessarily comply with standard specifications and are therefore not binding.

KRONE Internet

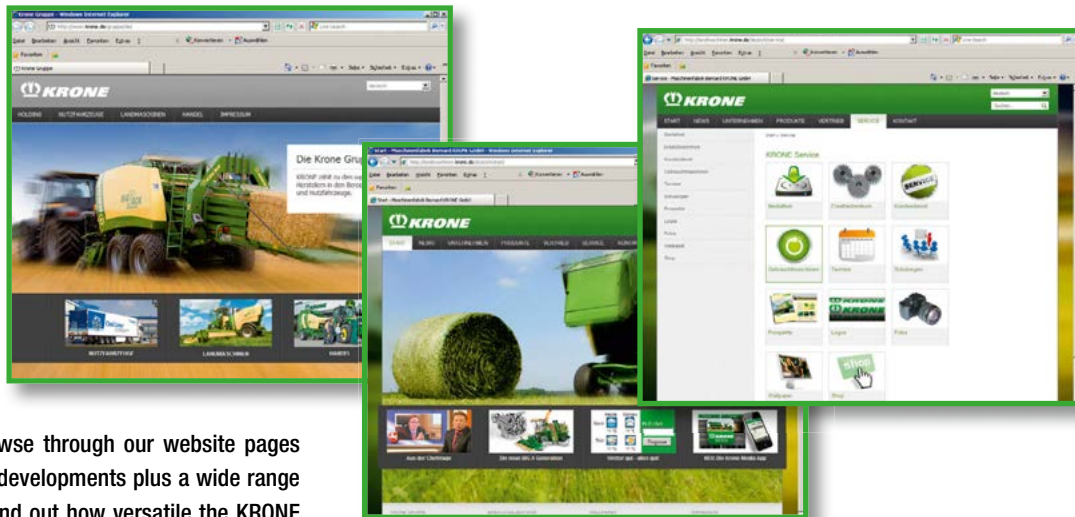

Discover the world at KRONE and browse through our website pages to find facts and figures and also new developments plus a wide range of services. Explore our website and find out how versatile the KRONE world is.



News

Click here to find up-to-the minute information about KRONE – from new product presentations to show reviews. Here you are at the pulse of KRONE life.



Products

Find extensive information on our full product range. This section holds everything you need – from video clips to manuals.



Sales organisation

Here you find a distributor in Japan as well as your local KRONE dealer who will be pleased to support you. This is where you find your KRONE partner who will be pleased to assist you.



Jobs

Would you like to join our company? KRONE is often looking for diligent and motivated staff to work at our farm machinery factory as well as at our commercial trailer production plant. So, this section is always worth a visit.



Media center

The KRONE 'database' holds thousands of documents, pictures, test reports and much more. Here you find very detailed information on KRONE products that are of special interest to you.



Events

Are you in for a KRONE live experience? Check out for KRONE events and look at a machine on show or watch it during a demonstration. After all, there is little that is more effective than a hands-on experience.



Service

Here you find all the service information you require – from a point of contact at the factory to finance schemes for your KRONE machine as well as training schemes for staff and users.



Download Center

Are you looking for a KRONE calendar for your desktop or a smart picture for your presentation? Here, at the KRONE download center, you will find plenty of useful material for a wide range of projects.



Used Machinery

KRONE often has a wide range of demonstration or exhibit machinery on offer. This is a good site to find your KRONE machine. Then contact your local KRONE dealer to arrange the details of a potential purchase.



Parts

24/7... This service gives you the opportunity to find your KRONE part at any time and without waiting. The KRONE Agroparts Portal has an article number and exact description for every part. You can order the part instantly at your local KRONE dealer by sending an e-mail to Agroparts.



KRONE shop

Are you looking for a gift or are you a collector of farm models? Then you should definitely shop around at our KRONE shop. We take your orders at any time of the day.

Your KRONE dealer

Maschinenfabrik Bernard KRONE GmbH

Heinrich-Krone-Straße 10
D-48480 Spelle

Telefon: +49 (0) 5977.935-0
Telefax: +49 (0) 5977.935-339

info.ldm@krone.de
www.krone.de