



For Earth, For Life  
**Kubota**

**M**

**KUBOTA DIESEL TRACTOR**  
**M6040/M7040/M8540**  
**M9540/M9540 Dual Speed**

A full-scale model change introduces a re-engineered and redesigned M-Series, ergonomically designed to provide optimal performance and comfort.

**NEW**  
**M9540**  
**Dual Speed**  
**Model**



\*This information is sourced from overseas and may not necessarily apply locally. It is essential that you confirm specifications and other information with your local Kubota dealer.



# M-SERIES

**You've never seen a tractor  
like this before.**



**That's because there's never been a tractor just like this. This is the new M-Series. With the new M-Series, high performance and affordability blend to bring you a line of tractors that can tackle just about anything you throw at it. Kubota has recreated one of its most durable and affordable models with a totally redesigned cab and hood, new direct injection engines, powerful front loaders and a host of ergonomic improvements. The M-Series is perfect for baling and cutting as well as cattle, dairy and many more applications. Take one for a test drive and you'll be convinced.**

*Note: Front work lights and canopy are optional on ROPS model.*





KUBOTA DIESEL TRACTOR  
**M6040/M7040**  
**M8540/M9540**



# A brand new M-Series from top to bottom, inside and out.

## **Newly Designed Cab**

The cab of our M-Series tractors has been completely redesigned. Rounded glass on the cab gives the operator more room and greater visibility. The height of the cab offers more headroom, and most of the levers and switches have been moved to the right side console for easier access. For greater visibility, the exhaust pipe has been relocated and the windshield now boasts a pantograph wiper.

## **Heater/Air Conditioner**

The heater and air conditioner have been improved for the new M-Series. We've relocated the air outlets to the dash tower to keep you cooler in the heat and warmer in the cold by optimizing the air flow around the operator.

## **Digital Panel**

A new digital LED panel makes viewing travel speed, PTO revolution and hour meter information clear and easy.

## **Independent PTO**

The Hydraulic Independent PTO helps you increase productivity. The M-Series comes with a standard 540/540E rpm Hydraulic Independent PTO (1,000 rpm is optional on M8540/M9540).

## **3-Point Hitch**

The Category I & II 3-point hitches provide fast and simple attachment of rear-mounted implements. Two external hydraulic cylinders provide equal lifting force and smooth transfer of hydraulic power for easy operation.

## **Hydraulics**

The M-Series' hydraulic pumps are now located on the side case instead of on the engine. This shortens the oil flow path increasing efficiency.





### **NEW DI (Direct Injection) Engine**

Kubota's revolutionary new center-direct injection system (E-CDIS) engines offer more durability, power and fuel efficiency. These technologically advanced engines also comply with EPA Tier II emissions standards.

### **New Hood Design**

The new high-strength steel hood design of the M-Series offers greater visibility over the hood especially during loader operation. Not to mention that it looks pretty great too.

### **F12/R12 Transmission (M6040/M7040)**

Synchronized four speeds of the main shift and a high/low range supply tractors with 12 Forward and 12 Reverse speeds, including 4 creep speed.

### **F18/R18 Transmission (M8540/M9540)**

For heavy-duty work the hydraulic-shuttle models of the M8540 and M9540 is equipped with an F18/R18 transmission, including creep speed.

### **F36/R36 Transmission (M9540 DHC-DS)**

Hydraulic Dual Speed, which further enhances the working capacity of the tractor, is included as standard on the M9540 DHC-DS.

### **Hydraulic Shuttle**

Shifting between forward and reverse is seamless and smooth with our new and improved M-Series Hydraulic Shuttle. A column-mounted lever with left-hand operation makes shifting easy. And when attaching implements, our improved inching feature is easy to perform, giving you the same feel as a half-clutch operation.

### **Limited Slip Differential**

The standard Limited Slip Differential (M7040/M8540/M9540) helps you maintain a stable travel speed should the drive wheel on either side of the tractor slip.

### **Convenient 4WD Engagement**

Stay productive by switching the 4-wheel drive on and off without stopping, even when moving out of a field onto a road. One simple switch does it all.

### **Bevel-Gear Front Axle**

The bevel-gear front axle provides the M-Series with better all-around maneuverability, especially for jobs in tight spaces. The greater front-axle oscillating angle also offers increased lateral operation on uneven terrain.



**Looks aren't everything. So we've made it more comfortable, ergonomic, practical, durable and spacious too.**

# NEW DESIGN

## **New Hood Design**

The sleek new slanted steel hood design of the M-Series looks great, but there's far more to it than meets the eye. It offers greater visibility over the hood of the tractor allowing you to see a greater field of view especially during loader operation. This hood can also be easily opened to provide convenient maintenance of the engine, AC condenser, radiator and air filter.



## **Headlights**

The M-Series now comes with halogen lights with a corner lamp. These lights are not only more efficient; they also provide more illumination from dusk to dawn.



*Note: Loader joystick is not standard. Comes packaged with loader valves.*

### Re-Engineered Seats

Reclining, weight-adjusted seats are standard equipment on all M-Series models. These comfortable seats were specifically designed to absorb shock, significantly reducing operator fatigue. We've also added a convenient manual holder in the seat back. The M9540 DHC-DS has a fully adjustable air suspension seat for extra comfort.



M40-Series seat for ROPS tractors



M9540 DHC-DS's seat

### Digital Panel

A new digital LED panel makes viewing vital functions of your M-Series tractor clear and easy. View travel speed, PTO revolution and hour meter information digitally. Analog indicators include a large tachometer, temperature gauge and fuel gauge. A battery warning light has also been added to the M-Series to prevent surprise battery failures.



Menu button

### Improved Steering Wheel and Column Design

The tilt steering column of the new M-Series boasts a couple new features. Designed to accommodate operators of many different sizes, the wheel and shuttle lever tilt together. To complement this feature, an easy-to-use foot pedal has also been added.



### Flat Deck (ROPS model) Full-Flat Deck (Cab model)

When operating a tractor, space comes at a premium. The M-Series flat deck neatly repositions most of the operational levers, including main shift and range lever, auxiliary control lever, hand-throttle, position draft control lever and PTO clutch lever, to the right of the seat. This offers the operator more legroom and far more comfort.





**More space and more visibility make  
our cab a great place to work.**

**Front Wiper**

To increase visibility on rainy days and to increase operator safety, the M-Series has a pantograph style front wiper. The unique design of this wiper gives it a wider coverage area.

**ULTRA**

**GRAND  
CAB**

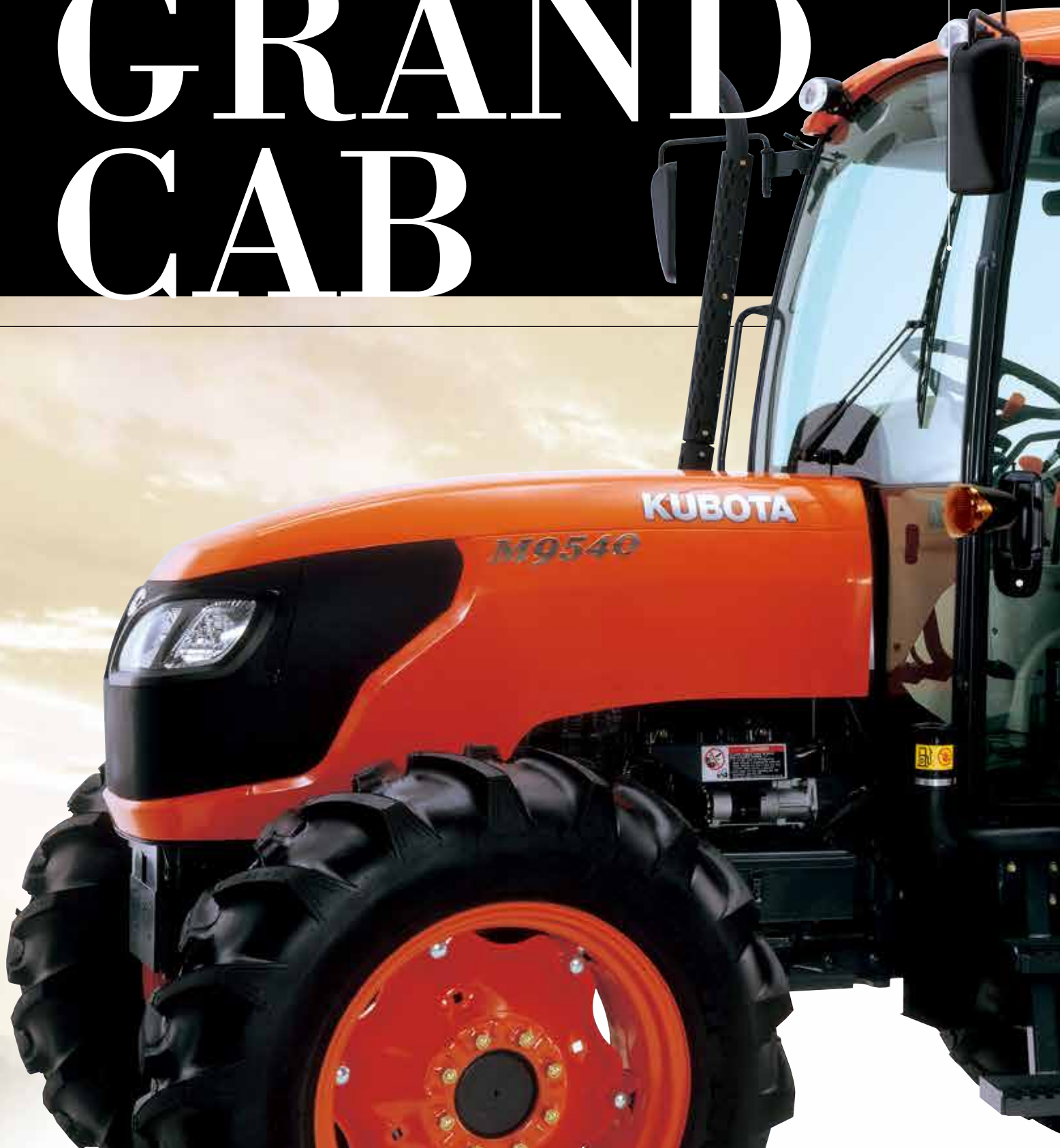





### **Rounded Glass**

We've rounded the cab glass of our M-Series tractors increasing the length of the cab by 5 cm and the width by 16 cm. This change provides the operator with more visibility and a more spacious feel—ideal for long days inside the cab.

Furthermore, we've increased the glass coverage area on the cab door, which makes it easier to get in and out of the cab.

### **Wide Fenders**

Wider and rounded steel fenders protect the operator from mud splashes and are equipped with large handles on both sides for easy mounting and dismounting.



### Corner Post Exhaust Pipe (Cab model)

The exhaust pipe on the M-Series has been repositioned along the right side of the cab providing the operator with a clear and unobstructed field of view.

### Cab Headroom

The arched beam in the front of the cab and relocated A/C components allowed M-Series designers to extend the height of the roof. This feature not only increases headroom, it also increases overall visibility, especially while using the loader.

# ULTRA GRAND CAB



### Newly Designed Cab

The innovative and stylish design of the new M-Series cab gives the operator a more comfortable and spacious year around environment.

### Easy-Step Tilt Steering Wheel

The steering wheel of the cab gets out of the way when the operator is dismantling the tractor. Just step on a pedal and raise the steering wheel to its original position.



### Control Lever Location

All levers are on the right side console for easy access. (except 4WD lever).

### Switch Location

For operational continuity, all electrical switches are also located on the right side console.

### Layout

The layout of all controls and levers were carefully considered to offer the operator the most ease of use.







### Heater/Air Conditioner

The heating and cooling unit is now located under the seat. The overall air circulation in the cab has been optimized by the cab's rounded glass as well as by placing the air outlets in the dash tower to keep you cooler on hot summer days and warmer on cold mornings, for year around environment control.



 Air Conditioning  
 Heating

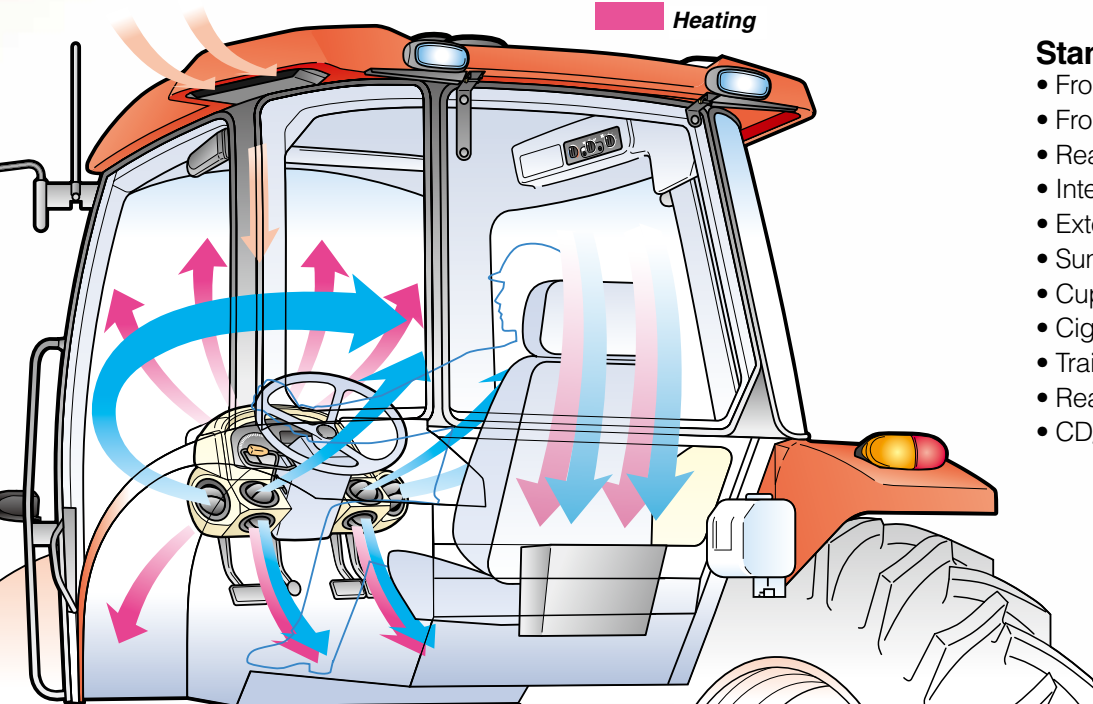

### Standard Equipment

- Front halogen work lights
- Front windshield wiper and washer
- Rear halogen work lights
- Interior dome light
- External left and right mirrors
- Sun visor
- Cup holder
- Cigarette lighter
- Trailer coupler
- Rear wiper and washer
- CD/radio



**Brand new engines give the M-Series tractors more power under the hood, which means better performance in the field.**

# NEW ENGINE

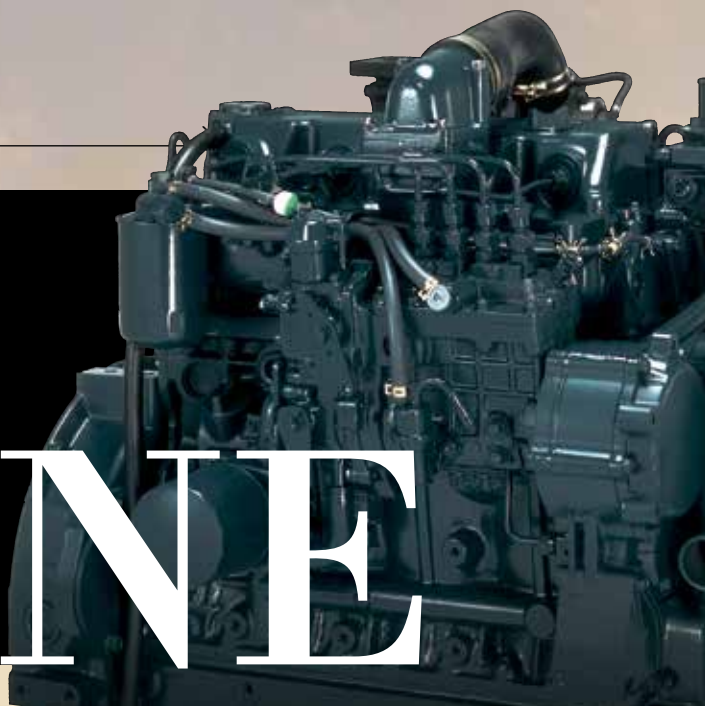

4-valve, Center-Direct Injection System

## ***DI (Direct Injection) Engine***

All of the four M-Series tractors are equipped with Kubota's revolutionary center-direct injection system (E-CDIS) engine. The E-CDIS engines offer a rare combination of more power, durability and better fuel efficiency, so you'll be able to get the job done quicker and more efficiently while minding your budget. These engines also boast lower noise levels, which equates to less stress and fatigue after long work days. Finally, all of Kubota's E-CDIS engines comply with EPA Tier II emission standards, so you can rest assured you're running a cleaner engine.

### **V3800DI-T**

V3800DI-T comes standard on both the M8540 and M9540 tractors. This hearty diesel engine employs a reliable 4-valve, center-direct injection system to achieve greater towing power. Combine this with the V3800DI-T's turbo charger and you have all the power you'll ever need, especially in the low rpm range, to perform heavy-duty tasks and during operations requiring sure-footed traction.



M9540: KUBOTA V3800DI-T

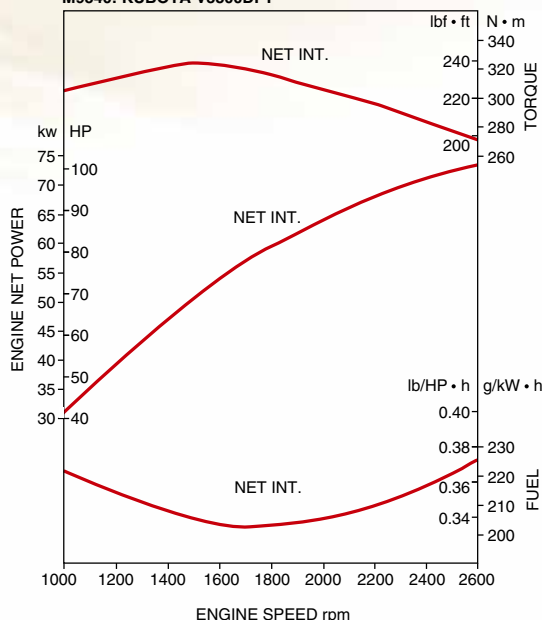





### New V3307-DI

The V3307-DI has been specially designed and built for M-Series tractors M6040 and M7040. The V3307-DI is a compact but powerful engine, offering an increased engine displacement of 3.3L. The M-Series tractors equipped with this high performance powerhouse provides high torque rise giving them the ability to take on even the most heavy-duty applications.



### Tier II Emission Regulations

The new and cleaner engines of the Kubota M-Series tractors comply with Tier II EPA emission regulations.

### Tier III Emission Regulations

The M9540 DHC-DS is equipped with an engine that complies with Tier III EPA emission regulations.

### Ladder frame crankshaft support structure

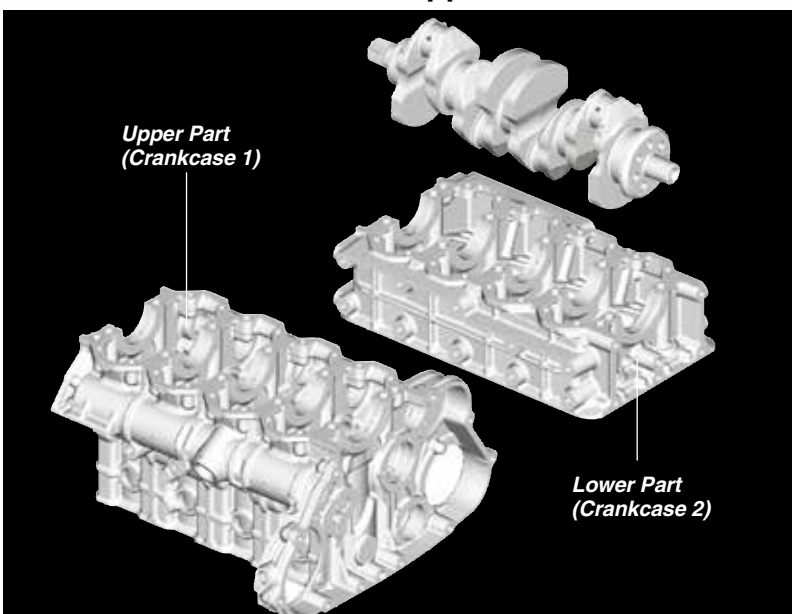

### Low Noise and Low Vibration

To help reduce operator fatigue and stress, the V3307-DI has been specially designed to minimize noise and vibration. This is accomplished through several innovative technologies. Noise is reduced through a ladder frame crankshaft support, giving the engine a stiffer structure and thus lower noise. Vibration is lowered through the application of compact, built-in balancers.

### Increased PTO Power

To give the M-Series even more power and to make working with large implements easier, Kubota has increased PTO horsepower on three of our M-Series models. The M6040 offers a sturdy 55 HP; the M8540 a hearty 75 HP; and the M9540 a full 84 HP.



**With multistage transmission and high travel speed, the M40-Series tractors really move you.**

# TRANSMISSION



M8540/M9540 Cab Models

## F12/R12 Transmission (M6040/M7040)

Synchronized four speeds of the main shift and a high/low range supply tractors with 12 Forward and 12 Reverse speeds, including creep speed. The main shift allows you to shift "on the fly" making operation smooth. Tailor this transmission to your needs by choosing from a hydraulic or synchronized shuttle transmission.



M6040/M7040 ROPS Models

## F18/R18 Transmission (M8540/M9540)

For heavy-duty work such as ploughing, hay work and heavy trailer applications the hydraulic-shuttle models of the M8540 and M9540 can be equipped with an F18/R18 transmission including creep speed. This transmission features six speeds of the main shift and a high/low/creep range giving it a total of 18 Forward and 18 Reverse speeds.

### M9540 DHC-DS TRAVELLING SPEED (F36/R36 with Dual Speed, 480/70R34) @ rated engine rpm

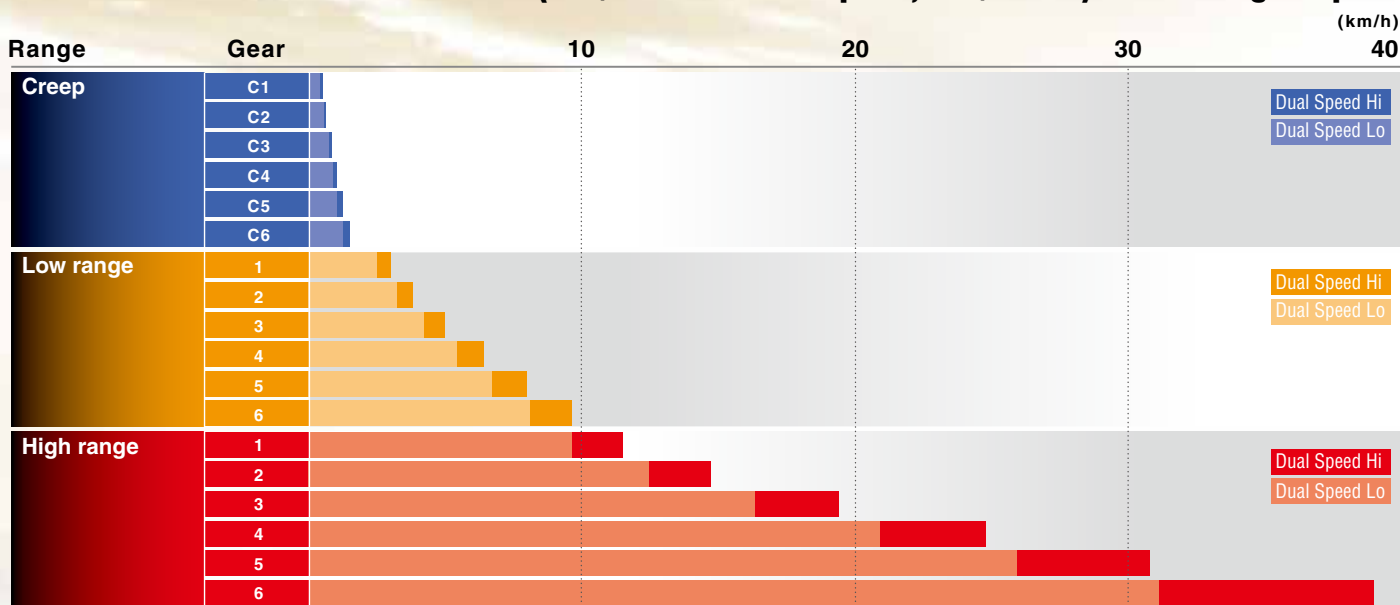





### Dual Speed (M9540 DHC-DS)

The Dual Speed feature provides instant upshift and downshift. If the load increases while in the Hi position, a simple press of the Dual Speed button will reduce speed and increase engine torque. The main shift features six synchromesh speeds for on-the-go shifting. Combine this with Dual Speed and the Hi/Lo/Creep range, and you have a total of 36F/36R speeds at your command.



### Hydraulic Shuttle

Better than ever, our Hydraulic Shuttle for the M-Series makes shifting between forward and reverse smooth and quick. With the Hydraulic Shuttle, a column-mounted lever, conveniently located next to the steering wheel,

does all the work. Boost productivity, especially while using loaders, by eliminating the need to depress the clutch every time you change directions. And when attaching implements, our improved inching feature is easy to perform, giving you the same feel as a half-clutch operation.



### Transmission Parking Lock (M8540/M9540)

An easy-to-operate transmission parking lock, located beside the main shift, is now independent from the main brakes. This lock is highly durable and reliable, providing precise parking on any terrain.



### Wet Disc Brakes (M8540 & M9540)

To decrease operator effort and increase overall tractor longevity, the Kubota M8540 and M9540 now come standard with Hydraulic Wet Disc Brakes. These brakes require less pedal effort and retain high performance efficiency even after repeated heavy-duty work.

### Limited Slip Differential (M7040, M8540 & M9540)

Limited Slip Differential on the front helps you maintain a stable travel speed should the drive wheel on either side of the tractor slip. A standard feature on the M7040, M8540 and M9540, Limited Slip Differential is perfect when reliable traction is essential.

### Convenient 4WD Engagement

Switching the 4-wheel drive on and off is easy and quick, and done with one simple lever. Best of all, there's no need to stop the tractor even when moving out of a field onto a road, so you can stay productive.

*(Do not engage while carrying heavy loads, or when rear wheel is spinning.)*





**M-Series Tractors give you the power, durability and longevity to take on just about any job you throw at them.**

# HEAVY DUTY

## **Hydraulics**

The hydraulics on the M-Series are state-of-the-art. External hydraulic cylinders improve the lifting power and offer easier maintenance. The M-Series offers a large pump capacity of 64.3 l/m (M8540/M9540). As a result, the front loader cycle times are short, increasing productivity and facilitating operation.

## **Bevel-Gear Front Axle**

The bevel-gear front axle provides the M-Series with greater all-around manoeuvrability. It enables M-Series tractors a tighter turning radius than ever before, an amazing 55 degrees. This makes easy work of jobs in tight spaces. The front-axle oscillating angle is also 20% greater offering increased stability on uneven terrain. Limited Slip Differential on the front (M7040/M8540/M9540) and Differential Lock on the rear are standard features, offering increased stability and traction on challenging ground conditions.





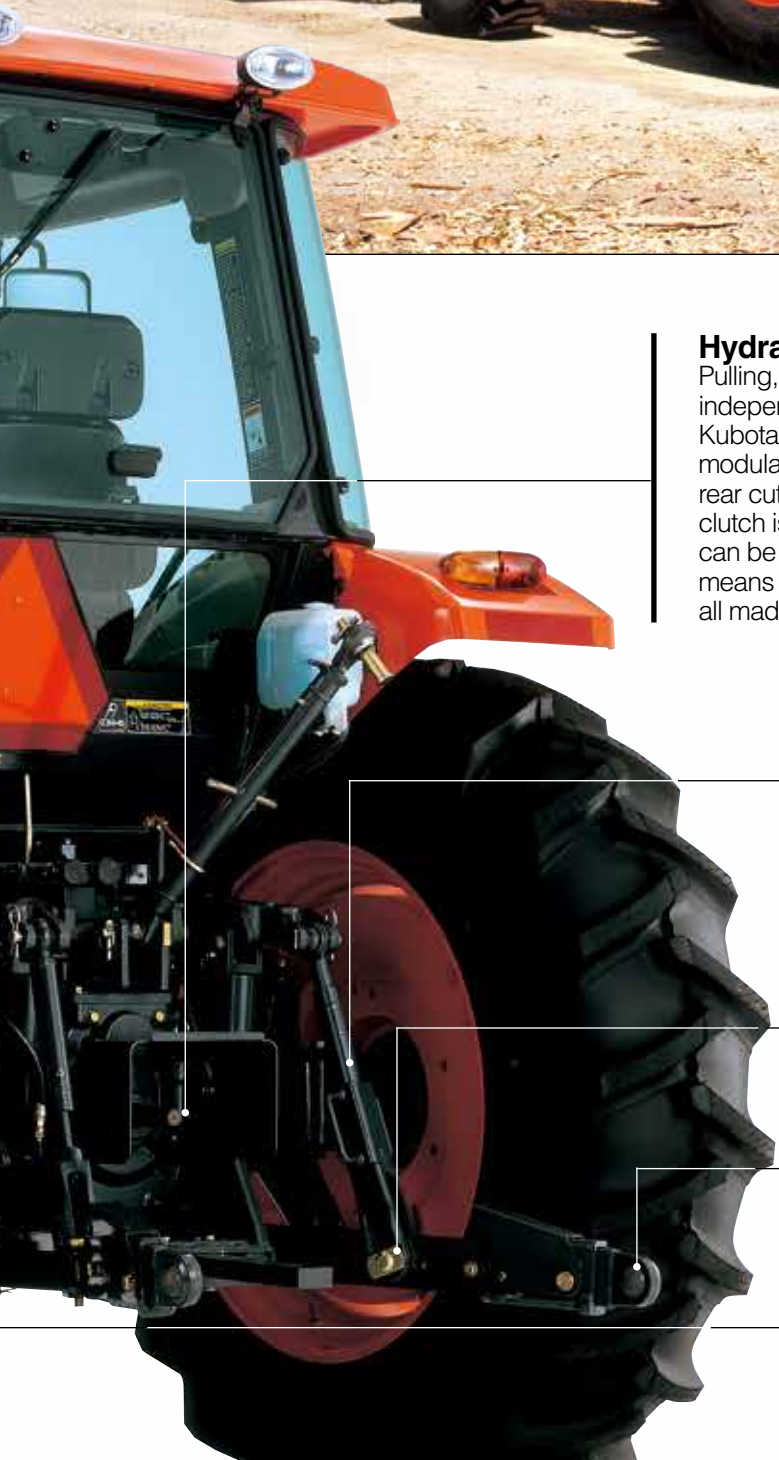

### **Hydraulic Independent PTO**

Pulling, lifting, cutting or baling; the standard 540/540E rpm hydraulic independent PTO (1000 rpm is optional on M8540/M9540) of the Kubota M-Series tractors makes your toughest work easier. Self-modulation engagement with a light touch means implements like a rear cutter engage smoothly. The PTO brake engages when the clutch is shut off and securely holds the PTO shaft. The PTO clutch can be hydraulically engaged and disengaged on the go. This means mowing, operating hay equipment or spraying orchards are all made more efficient.

### **3-Point Hitch**

The Category I & II (M6040/M7040) and Category II (M8540/M9540) 3-point hitches provide fast and simple attachment of rear-mounted implements. On the M6040 and M7040 the capacity is 1500kg and on the M8540 and M9540 it is 3200kg. The M9540 DHC-DS is also equipped with an external 3-point hitch lift lever.

### **Floating Lift Rods**

The floating lift rods are standard on M8540 and M9540, giving the M-Series tractors a smoother ride and enhanced traction while using the 3-point hitch, especially on uneven terrain.

### **Telescopic Lower Link Ends**

The telescopic lower link ends, standard on all M-Series models, further facilitate implement attachment.

### **Large diameter cylinder**

Large diameter cylinders boost lifting power by as much as 50%—perfect for large implements and larger farm uses.



# The M-Series Front Loader puts power and visibility front and center.

## Lifting Power and Height

Two separate boom cylinder fulcrum points (Power position and Height position) give you the option to increase the M-Series Front Loader lifting power or height based on your needs. When using the pallet fork or bale spear you may want to set the fulcrum to give you more height. For bucket work, a lower setting offers more power.

# FRONT LOADER

## All New Design

The Kubota M-Series Front Loader has undergone a full model change. The new loaders have dramatically increased lifting power, perfect for farm use. Its design has also been fully integrated into the new tractor design with a slanted boom to match the tractor's hood. This not only gives the M-Series a sleeker look it supplies the operator with more visibility and clearer sight lines to the bucket and loader sides.

## Frame

The frame of the front loader maintains its sturdy, thick steel frame, but its design has been simplified by removing braces and connectors. This helps to lessen effort and shorten the time it takes to attach the loader and offers increased visibility.



## Protected Cylinder Tubes

To better protect the tractor hydraulics and offer the operator more visibility, the hydraulic tubes are neatly tucked inside the loader boom. Hydraulic tube covers further provide protection from wear and tear.



## Improved Bucket

Some recent improvements in the loader bucket include a round back, which increases durability and makes dumping sand and soil easier.

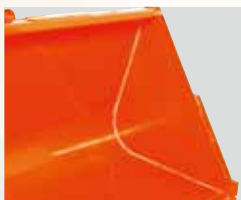

Standard bucket size is 72"; large capacity buckets (for LA1353 only) are 84".





## Quick-Mount Attach/Detach

Attach or detach the front loader in moments without the use of tools. The boom stands and mounting pins make this task a snap, allowing an extra measure of productivity and tractor versatility. A single-lever Hydraulic Quick Coupler, available for the loader's hydraulic fittings, allows you to release all four lines at once.



## Euro-type quick hitch

A standard feature on the LA1153/LA1353 Loaders, the quick hitch will let you quickly attach and detach a variety of Euro-type attachment. Kubota original bucket, pallet fork, and bale spear are available.

## 4-Bar Linkage

Thanks to an upgraded 4-bar bucket linkage, the rollback and dumping angle has been increased for quicker scooping and dumping.

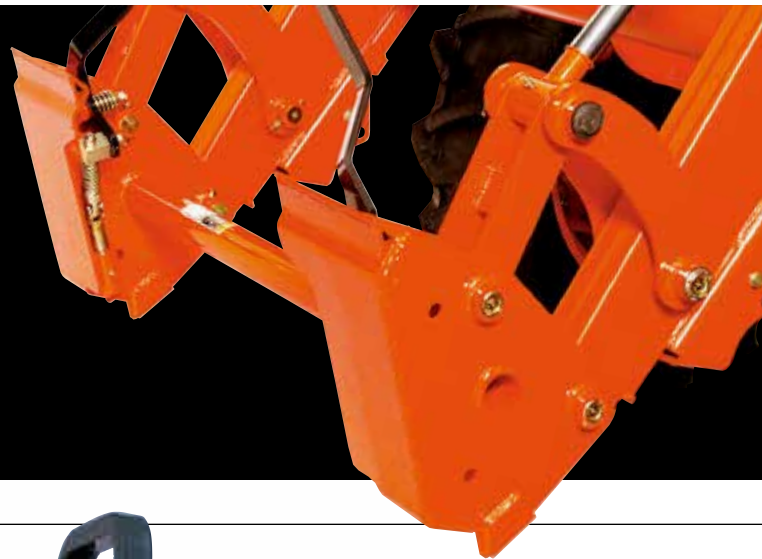

## Joystick Control

Located in front of the control console for easy access, the joystick offers you the ability to control the movement and speed of the loader with a single lever. The Series Circuit makes simultaneous boom and bucket operation possible, while the Regenerative Bucket Dump Circuit enables quick dumping for efficient operation with quick cycle times.



## Rubber Caps

A new feature, rubber caps, prevent grease drips helping to keep the operator's clothes clean. The caps also give the loader a more appealing look.

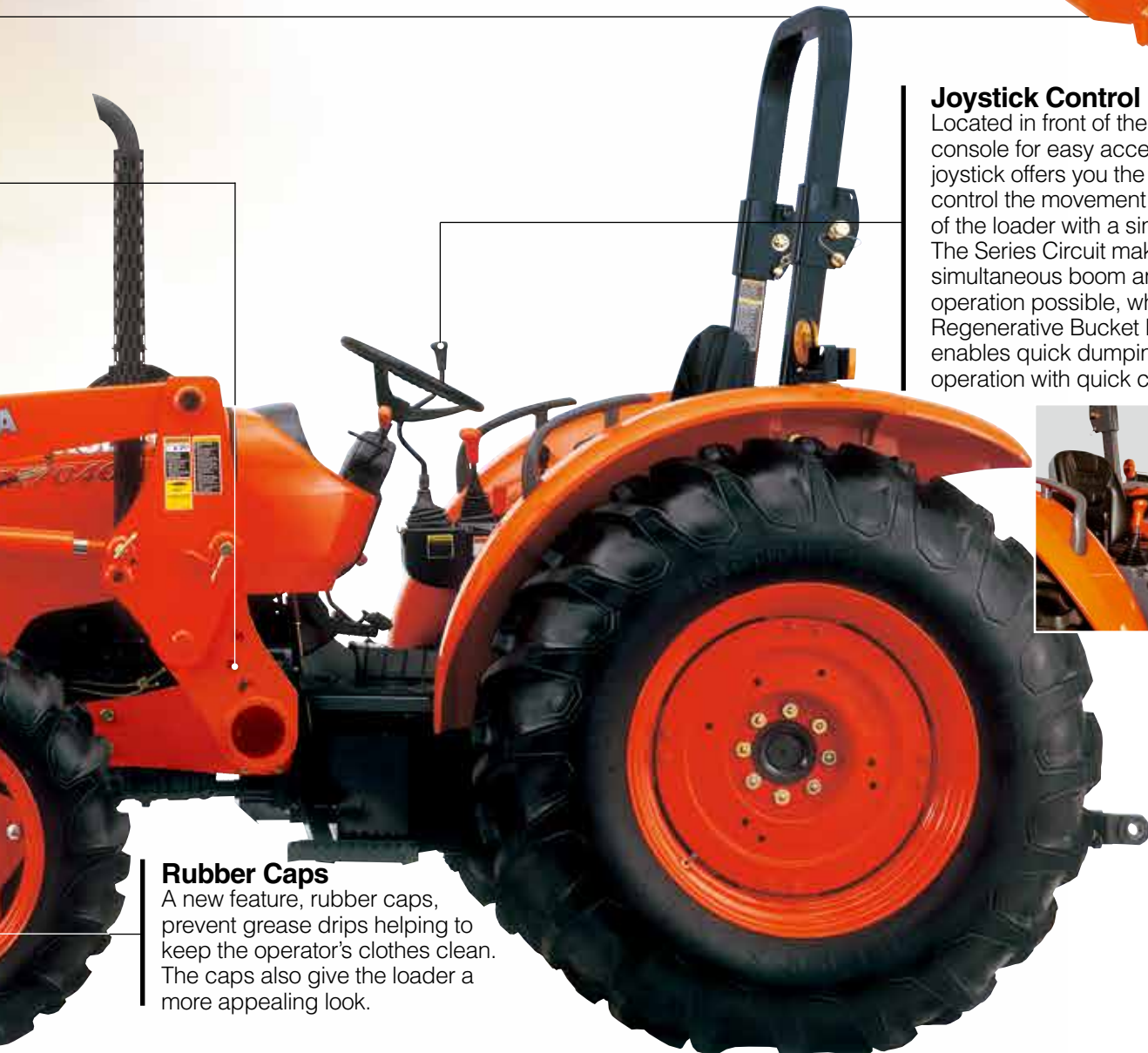





# FRONT LOADER OPTIONS

## Hydraulic Self-Leveling Valve

This feature allows the operator to raise or lower the loader boom while keeping the bucket level to the ground. This will help prevent spills when carrying soil or sand and will make pallet handling smooth and easy. This function can be switched off for times when bucket angles are more advantageous, for instance, during excavation.



## Kubota Shockless Ride (KSR)

The KSR absorbs loader shock and reduces operator fatigue. This option is perfect if your tasks include a great deal of tight turns or lifting and dumping of heavy loads. It effectively takes the "bounce" out of handling round bales.



## Single-Lever Hydraulic Quick Coupler

The optional quick coupler allows the operator the ability to attach all four hoses at once. This makes attaching and detaching quick and easy, even when you're doing it often.



## 3rd Function Valve

The optional 3rd function valve broadens the scope of the front loader operation by enabling the use of a grapple bucket and various other hydraulically controlled attachments. The 3rd function valve can be activated with buttons located on the grip of the joystick.







# LOADER SPECIFICATIONS

Model	LA1153		LA1353		
	M6040, M7040		M8540, M9540		
Tractor applications	Height position		Power position		
Boom Cylinder Fulcrum	Height position		Power position		
Maximum Lift Height (Pivot pin)	mm	3370	2977	3720	3390
Clearance w/Attachment Dump	mm	2577	2172	2880	2545
Reach @ Maximum Height	mm	357	811	536	927
Maximum Dump Angle	degrees	43	60	49	60
Reach w/Attachment on Ground	mm	1947		2230	
Maximum Rollback Angle	degrees	43		40	
Digging Depth(When Bucket is Level)	mm	134	111	120	105
Overall Height in Carry Position	mm	1573		1716	
Material Bucket Width/capacity(Heaped)	m <sup>3</sup>	0.55		0.64	
Lift Capacity(Bucket Center)	kg	1055	1150	1230	1350
Raising Time to Full Height w/out Load <sup>(1)</sup>	second	4.7		4.1	
Lowering time w/out Load (powerdown) <sup>(1)</sup>	second	3.5		3.0	
Attachment Rollback Time	second	3.0		2.1	
Attachment Dumping Time	second	2.7		1.8	

<sup>(1)</sup>w/ Standard valves.



# SPECIFICATIONS

Model		M6040	M7040
<b>Engine</b>		V3307-DI	V3307-DI
Type (Make : KUBOTA)			
No. of cylinders / Aspiration		4 / Natural	4 / Natural
Engine net power	HP (kW)	62 (46.3)	68 (50.7)
PTO power	HP (kW)	55 (41.0)	62 (46.3)
Total displacement	cc	3331	
Engine rpm			
Fuel tank capacity	ℓ	70 on ROPS model, 110 on CAB model	
Alternator			45 Amp on ROPS model,
<b>Transmission</b>			
No. of speeds		F12 / R12 (w/creep)	
Main gear shift (8 speeds)			
Hydraulic shuttle			Standard, Dash-
Max. travelling speed @ max. engine RPM	Km/h	30	31
Main clutch type			
Brake type		Mechanical wet disc	
Mechanical differential lock		Rear standard	
4WD clutch type			
<b>PTO</b>			
Type			Live-independent, hydraulic
Speed	rpm		
<b>Hydraulics</b>			
Pump capacity (3-Point Hitch)	ℓ/min.	41.6	
3-Point Hitch			
Category		I / II	
Control system			
Lift capacity at 24 in. behind lift point	kg	1500	
Cylinder type			
No. of standard remote valves			
<b>Other features</b>			
4WD drive system			
Steering			
Tilt steering			
Hood type			
Pedal type			
Deck type (ISO-mounted w/ rubber mat)			
Panel type			
Fender shape			
<b>Standard tire size</b>			
Front / Rear	Standard	9.5 x 24 / 14.9 x 28	9.5 x 24 / 16.9 x 30
	Option	280/85R20 / 380/70R28	280/85R24 / 280/85R30
	Option (vinyard)	-	-
<b>Dimensions &amp; weight</b>			
Overall length (ROPS model)	mm	3445	
Overall length (CAB model)	mm	3445	
Overall height (top of ROPS / CAB)	mm	2460 / 2535	2470 / 2545
Overall width (Minimum, ROPS / CAB)	mm	1860 / 1860	
Wheelbase (ROPS / CAB)	mm	2050 / 2110	
Crop clearance (Front Axle)	mm	420	430
Tread width	Front	mm	1330-1430
	Rear	mm	1420-1720
Turning Radius (w/o brake)	m	3.6	
Tractor weight (ROPS / CAB)	kg	2170 / 2430	2180 / 2440

The company reserves the right to change the above specifications without notice.

This brochure is for descriptive purpose only. Some of the items pictured in this brochure are optional, and not standard equipment.

Please contact your local Kubota dealer for warranty, safety or product information.

For your safety, KUBOTA strongly recommends the use of a Rollover Protective Structure (ROPS) and seat belt in almost all applications.



<b>M8540</b>	<b>M9540</b>	<b>M9540 DHC-DS</b>
V3800DI-T	V3800DI-T	V3800DI-TE3
E-CDIS, Direct Injection		
4/Turbocharged	4/Turbocharged	4/Turbocharged
84.6 (63.1)	94.5 (70.5)	95 (70.8)
75 (56.0)	84 (62.7)	84 (62.7)
	3769	
2600		
90 on ROPS model, 110 on CAB model		110
60 Amp on CAB model		60 Amp
F18 / R18 (w/creep)		F36 / R36 (w/creep and Dual Speed)
Fully synchronized		
mounted lever on ROPS model, Column-mounted lever on Cab models		
35	35	39
Multiple wet disc		
Hydraulic wet disc		4 wheel hydraulic wet disc
Rear standard & front Limited Slip Differential		
Mechanical		Electric over hydraulic
PTO with PTO brake, wet clutch		Live-independent, electric over hydraulic PTO
540 / 540E		
	64.3	
Telescopic lower link ends, Telescopic stabilizers		
	II	
Position, draft (top link sensing) & mixed control		
3200		3300
Two external cylinders		
2 (SCD, S/D Acting), 3rd & flow control valve optional		
Bevel gear type		
Hydraulic power steering		
Standard		
Full open, slanted type		
Hanging type		
Semi-flat on ROPS model, full-flat on CAB model		
Electronic		
Wide, round		
320/85R24 / 460/85R30	320/85R24 / 460/85R30	360/70R24 / 480/70R34
320/85R24 / 420/85R34	320/85R24 / 420/85R34	320/85R24 / 460/85R30
335/80R20 / 380/85R30	335/80R20 / 380/85R30	335/80R20 / 380/85R30
	3760	
3760		3955
2465 / 2545	2490 / 2570	2650
1980 / 1980		2010
2250 / 2250		2250
465	465	456
1420-1520	1520-1620	1540-1660
1520-1920		1500-1698
4.2		5.8
2450 / 2740	2500 / 2800	3305





M95X/M105X/M125X



M95S/M105S

***Kubota also offers the M95X/M105X/M125X and the M95S/M105S. They boast the power, durability and affordability you're looking for.***

©2018 Kubota Corporation

# Kubota

## **Kubota Australia Pty Ltd**

25-29 Permas Way, Truganina VIC, 3029 Australia  
Freecall: 1800-334-653  
Email: sales@kubota.com.au

Web Site: <http://www.kubota.com.au>

## **CB Norwood Distributors Ltd**

888 Tremaine Avenue, Palmerston North, 4440 New Zealand  
Tel: 06-356-4920  
Email: info@norwood.co.nz

Web Site: <http://www.kubota.co.nz>

**Kubota  
Genuine Parts**  
for maximum  
performance,  
durability and  
safety

